

LENNOX®

© 2003 Lennox Industries Inc.
Dallas, Texas, USA

504,741M
6/2003

USER'S INFORMATION MANUAL

G61MP SERIES

GAS FURNACE

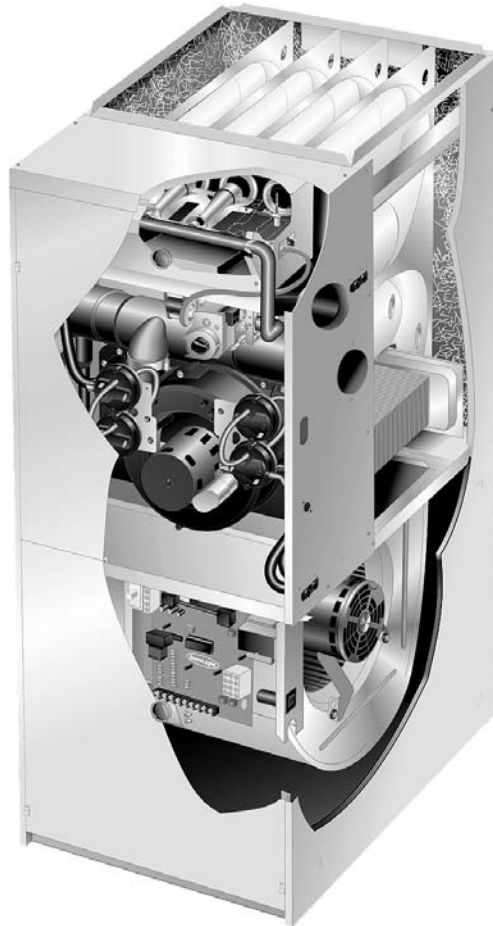

TP Technical
Publications
Litho U.S.A.



⚠ WARNING

FIRE OR EXPLOSION HAZARD.

Failure to follow safety warnings exactly could result in serious injury, death, or property damage.



Do not store or use gasoline or other flammable vapors and liquids in the vicinity of this or any other appliance.

Installation and service must be performed by a qualified installer, service agency or the gas supplier.

WHAT TO DO IF YOU SMELL GAS:

- Do not try to light any appliance.
- Do not touch any electrical switch; do not use any phone in your building.
- Leave the building immediately.
- Immediately call your gas supplier from a neighbor's phone. Follow the gas supplier's instructions.
- If you cannot reach your gas supplier, call the fire department.



G61MP Parts Identification

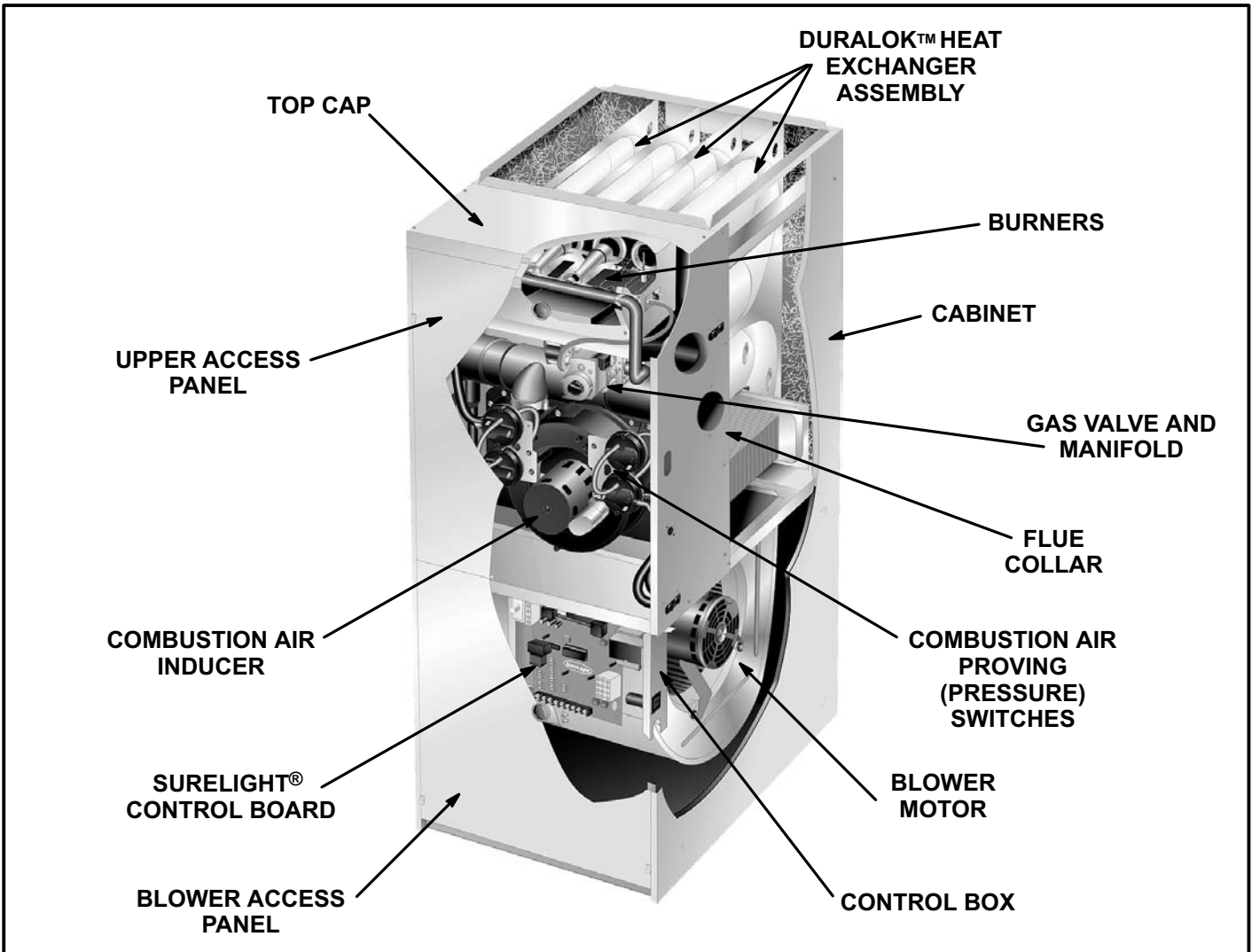

FIGURE 1

⚠ WARNING

Product contains fiberglass wool.

Disturbing the insulation in this product during installation, maintenance, or repair will expose you to fiberglass wool. Breathing this may cause lung cancer. (Fiberglass wool is known to the State of California to cause cancer.)

Fiberglass wool may also cause respiratory, skin, and eye irritation.

To reduce exposure to this substance or for further information, consult material safety data sheets available from address shown below, or contact your supervisor.

Lennox Industries Inc.
P.O. Box 799900
Dallas, TX 75379-9900

NOTE - This manual must be left with the equipment user.

⚠ WARNING

Do not set thermostat below 60°F (16°C) in heating mode. Setting thermostat below 60°F (16°C) reduces the number of heating cycles. Damage to the unit may occur that is not covered by the warranty.

⚠ WARNING

If overheating occurs or if gas supply fails to shut off, shut off the manual gas valve to the furnace before shutting off electrical supply.

⚠ CAUTION

Before attempting to perform any service or maintenance, turn the electrical power to unit OFF at the disconnect switch.

⚠ WARNING

Do not use this furnace if any part has been under-water. A flood-damaged furnace is extremely dangerous. Attempts to use the furnace can result in fire or explosion. Immediately call a qualified service technician to inspect the furnace and to replace all gas controls, control system parts, and electrical parts that have been wet or to replace the furnace, if deemed necessary.

⚠ IMPORTANT

Any additions, changes, or conversions required in order for the appliance to satisfactorily meet the application needs must be made by a Lennox service technician using factory specified and approved parts.

⚠ WARNING

Improper installation, adjustment, alteration, service or maintenance can cause property damage, personal injury or loss of life. Installation and service must be performed by a qualified installer, service agency or the gas supplier.

Safety Instructions

- 1 - Keep the furnace area clear and free of combustible material, gasoline, and other flammable vapors and liquids. If it is installed in an insulated area, the furnace must be kept free of insulating material. Insulating material may be combustible.
- 2 - **DO NOT** obstruct air flow to unit. Unit must receive an unobstructed flow of combustion and ventilating air. **DO NOT** block or obstruct air openings on the furnace or air openings to the area in which the furnace is installed. Take care to maintain established clearances surrounding the furnace.
- 3 - **DO NOT** store chlorine or fluorine products near unit or introduce these products into the combustion air. These products can cause furnace corrosion.
- 4 - **DO NOT draw return air from a room where this furnace, or any other gas appliance (ie., a water heater), is installed.** When return air is drawn from a room, a negative pressure is created in the room. If a gas appliance is operating in a room with negative pressure, the flue products can be pulled back down the vent pipe and into the room. This reverse flow of the flue gas may result in incomplete combustion and the formation of carbon monoxide gas. This toxic gas might then be distributed throughout the house by the furnace duct system.

⚠ WARNING

The blower door must be securely in place when the blower and burners are operating. Gas fumes, which could contain carbon monoxide, can be drawn into the living space resulting in personal injury or death.

Your furnace is a gas appliance. It is critical that the gas supplied to the unit be completely burned to avoid the production of carbon monoxide gas. Complete combustion of the gas requires, but is not limited to, correct gas pressure and gas flow rate, adequate combustion, air, and proper venting.

⚠ WARNING

Carbon monoxide gas is invisible, odorless and toxic.

Exposure to carbon monoxide gas can cause personal injury and even death to all occupants, including pets. Any item that is powered by or gives off heat from a combustion process (including lawn mowers, automobiles, and fireplaces) has the potential to produce carbon monoxide gas. Because of this, **Lennox recommends the use of a carbon monoxide detector in your home, even if you do not own gas appliances.** Reliable detectors are available at reasonable retail prices. Contact your Lennox dealer for more details about this investment in your safety.

Your furnace is designed to meet standards set by national agencies, and to operate safely when properly installed and maintained. However, the unit's performance can be greatly impacted by the individual installation and the operating environment. It is your responsibility to ensure that this appliance is maintained. Proper maintenance is critical for your safety and the satisfactory operation of the product. **Lennox strongly recommends annual inspection and maintenance of this appliance.** Contact your Lennox dealer for an inspection by a qualified service technician.

Lighting Information & Operation

⚠ WARNING

If you do not follow these instructions exactly, a fire or explosion may result causing property damage, personal injury or death.

BEFORE LIGHTING the unit, smell all around the appliance area for gas. Be sure to smell next to the floor because some gas is heavier than air and will settle on the floor.

The gas valve on the G61MP may be equipped with either a gas control knob or gas control lever. Use only your hand to push the lever or turn the gas control knob. Never use tools. If the the lever will not move or the knob will not push in or turn by hand, do not try to repair it. Call a qualified service technician. Force or attempted repair may result in a fire or explosion.

Placing the G61MP furnace into operation:

G61MP units are equipped with a SureLight® ignition system. Do not attempt to manually light burners on this furnace. Each time the thermostat calls for heat, the burners will automatically light. The ignitor does not get hot when there is no call for heat on units with SureLight® ignition system.

Operating the Gas Valve (Figures 3 and 4)

- 1 - **STOP!** Read the safety information at the beginning of this section.
- 2 - Set the thermostat to the lowest setting. See figure 2.
- 3 - Turn off all electrical power to the unit.

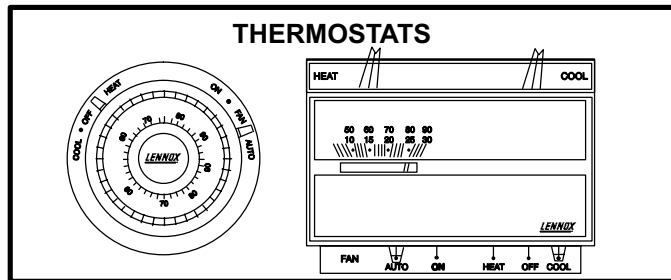



FIGURE 2

- 4 - This furnace is equipped with an ignition device which automatically lights the burners. Do **not** try to light the burners by hand.
- 5 - Remove the upper access panel.
- 6 - *White Rodgers 36E Gas Valve* - Switch gas valve lever to **OFF**.
Honeywell VR8205 Gas Valve - Turn knob on gas valve clockwise  to **OFF**. Do not force. See figure 4.
- 7 - Wait five minutes to clear out any gas. If you then smell gas, **STOP!** Immediately call your gas supplier from a neighbor's phone. Follow the gas supplier's instructions. If you do not smell gas go to next step.
- 8 - *White Rodgers 36E Gas Valve* - Switch gas valve lever to **ON**. See figure 3 for the White Rodgers 36E valve.
Honeywell VR8205 Gas Valve - Turn knob on gas valve counterclockwise  to **ON**. Do not force.

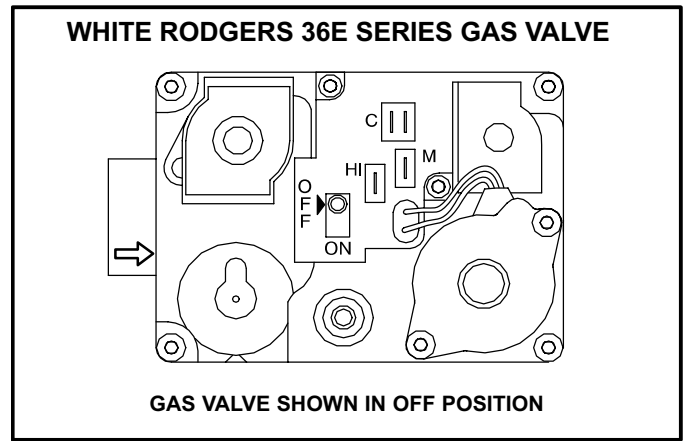

FIGURE 3

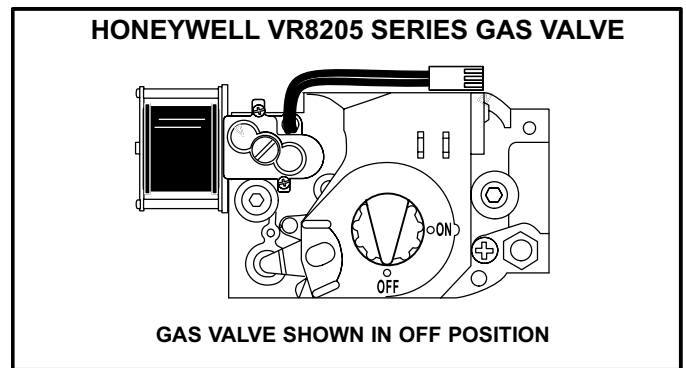



FIGURE 4

- 9 - Replace the upper access panel.
 - 10 - Turn on all electrical power to to the unit.
 - 11 - Set the thermostat to desired setting.
- NOTE - When unit is initially started, steps 1 through 11 may need to be repeated to purge air from gas line.*
- 12- If the appliance will not operate, follow the section "Turning Off Gas to the Unit" and call your service technician or gas supplier.

Turning Off Gas to the Unit

- 1 - Set the thermostat to the lowest setting.
- 2 - Turn off all electrical power to the unit if service is to be performed.
- 3 - Remove the upper access panel.
- 4 - *White Rodgers 36E Gas Valve* - Switch gas valve lever to **OFF**.
Honeywell VR8205 Gas Valve - Turn knob on gas valve clockwise  to **OFF**. Do not force.
- 5 - Replace the upper access panel.

Filters

All G61MP filters are installed external to the unit. Filters should be inspected monthly. Clean or replace the filters when necessary to ensure proper furnace operation. Replacement filters must be rated for high velocity airflow. Table 1 lists recommended filter sizes.

A filter must be in place whenever the unit is operating.

TABLE 1

| Furnace Cabinet Size | Filter Size | |
|----------------------|-----------------|-----------------|
| | Side Return | Bottom Return |
| 17-1/2" | 16 X 25 X 1 (1) | 16 X 25 X 1 (1) |
| 21" | 16 X 25 X 1 (1) | 20 X 25 X 1 (1) |
| 24-1/2" | 16 X 25 X 1 (2) | 24 X 25 X 1 (1) |

Maintenance

A qualified service technician should inspect the complete system each season (heating and cooling). The following maintenance procedures should only be conducted by a qualified service technician. **Do not attempt to service the unit in any way.**

⚠ WARNING

ELECTRICAL SHOCK, FIRE, OR EXPLOSION HAZARD.

Failure to follow safety warnings exactly could result in dangerous operation, serious injury, death or property damage.
 Improper servicing could result in dangerous operation, serious injury, death, or property damage.
 Before servicing, disconnect all electrical power to furnace.
 When servicing controls, label all wires prior to disconnecting. Take care to reconnect wires correctly.
 Verify proper operation after servicing.

Venting System

⚠ WARNING

Asphyxiation Hazard

The exhaust vent for this furnace must be securely connected to the furnace flue collar at all times.
 For your safety and to fulfill the terms of the limited warranty, a qualified service technician must annually inspect this furnace and its vent system.

Annually (before heating season) inspect furnace venting system, vent cap, heat exchanger, and burners for corrosion, deterioration, or deposits of debris. Remove any obstructions.

Inspect the furnace for obvious signs of deterioration. Inspect the furnace venting system to make sure it is in place, physically sound, and without holes, corrosion, or blockage.

Vent pipe must be clear and free of obstructions and must slope upward away from the furnace.

Inspect the furnace return air duct connection to ensure duct is sealed to the furnace and terminates outside the space containing the furnace.

Inspect the physical support of the furnace to guarantee that it is sound without sagging, cracks or gaps around base and it maintains seal between base and support.

Inspect and clean the condensate trap and drain.

During a seasonal check the service technician will inspect the indoor blower, burner flames and electrical connections along with the venting system.

Blower

Check the blower wheel for debris and clean if necessary. The blower motors are prelubricated for extended bearing life. No further lubrication is needed.

⚠ WARNING

The blower access panel must be securely in place when the blower and burners are operating. Gas fumes, which could contain carbon monoxide, can be drawn into living space resulting in personal injury or death.

Burner Flame

⚠ CAUTION

To ensure proper operation, a qualified technician should annually check the burner flame.

Electrical

- 1 - Check all wiring for loose connections.
- 2 - Check for the correct voltage at the furnace (furnace operating).
- 3 - Check amp-draw on the blower motor.
 Motor Nameplate _____ Actual _____

Service Reminder

Call your Lennox service technician if the unit will not operate. Before calling, always check the following to be sure service is required:

- 1 - Check that electrical disconnect switches are **ON**.
- 2 - Check room thermostat for proper setting.
- 3 - Replace any blown fuses or reset circuit breakers.
- 4 - Gas valve should be **ON**.
- 5 - Air filter should not be plugged, which will limit air flow.
- 6 - Is gas turned on at meter?
- 7 - Is manual main shut-off valve open?

Record the model and serial number of the furnace. These numbers are on the unit nameplate, which is located on the blower deck below the combustion air inducer.

Serial Number _____

Model Number _____

Safety Precautions

If you discover any of the following, shut down your unit, and contact a Lennox dealer for an inspection by a qualified technician.

- If you repeatedly hear any new or unfamiliar sounds while your unit is operating, there may be a problem. For example, poorly performing burners can produce unfamiliar noises.
- If you smell any unusual odors, your unit may be operating improperly. For example, units can give off unfamiliar odors if components are required to operate in abnormal conditions.
- Look for visible signs of a malfunctioning unit. Examples include unusual amounts of condensate on windows inside your house, visibly burnt components or unusual dirt or rust accumulations on the vent pipe or in the unit.
- If you experience headache, nausea, fatigue, or dizziness, the cause could be exposure to carbon monoxide gas. This is often misdiagnosed as the flu because symptoms are similar. If you suffer from flu-like symptoms that are exaggerated at home, but seem to subside while you are away from the house, exposure to carbon monoxide could be the cause.

Your vigilance may pay off in early detection of a problem before either personal injury or property damage occurs. Do not hesitate to contact a qualified service technician as an investment in your well being.

Planned Service

You should expect a service technician to check the following items during an annual inspection. Power to the unit must be shut off for the service technician's safety.

Fresh air grilles and louvers (on the unit and in the room where the furnace is installed) - Must be open and unobstructed to provide combustion air.

Burners - Must be inspected for rust, dirt, or signs of water.

Vent pipe - Must be inspected for signs of water, damaged or sagging pipe, or disconnected joints.

Unit appearance - Must be inspected for rust, dirt, signs of water, burnt or damaged wires, or components.

Blower access door - Must be properly in place and provide a seal between the return air and the room where the furnace is installed.

Return air duct - Must be properly attached and provide an air seal to the unit.

Operating performance - Unit must be observed during operation to monitor proper performance of the unit and the vent system.

Combustion gases - Flue products must be analyzed and compared to the unit specifications.

Problems detected during the inspection may make it necessary to temporarily shut down the furnace until the items can be repaired or replaced.

Pay attention to your furnace. Situations can arise between annual furnace inspections that may result in unsafe operation. For instance, items innocently stored next to the furnace may obstruct the combustion air supply. This could cause incomplete combustion and the production of carbon monoxide gas.

Repair Parts List

The following repair parts are available through Lennox dealers. When ordering parts, include the complete furnace model number listed on the CSA International nameplate -- Example: G61MP-36B-045-1.

Cabinet Parts

- Upper access panel
- Blower access panel
- Top Cap

Control Panel Parts

- Transformer
- SureLight® integrated control board
- Door interlock switch
- Circuit Breaker

Blower Parts

- Blower wheel
- Motor
- Motor mounting frame
- Motor capacitor
- Blower housing cutoff plate

Heating Parts

- Flame Sensor
- Heat exchanger assembly
- Gas manifold
- Combustion air inducer
- Gas valve
- Main burner cluster
- Main burner orifices
- Pressure switches
- Ignitor
- Primary limit control
- Secondary limit
- Flame rollout switches
- Combustion air inducer auxiliary limit